

Instruction manual

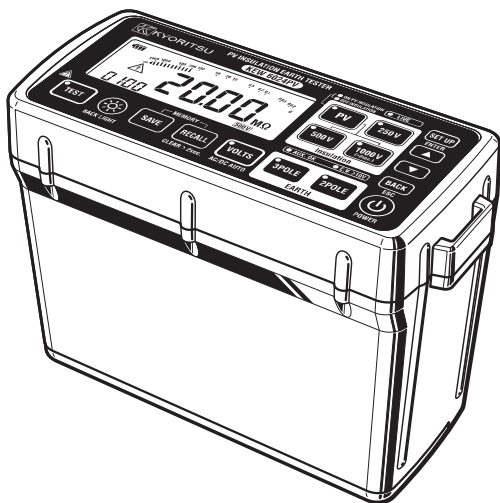

PV insulation earth tester

KEW6024PV



**KYORITSU ELECTRICAL
INSTRUMENTS WORKS, LTD.**

Contents

1. Safety warnings	1
2. Features.....	7
3. Specifications.....	9
4. Name of parts	14
5. Accessories.....	19
6. Preparations for measurement	21
6-1 Battery voltage check	21
6-2 Attaching metal tip/ adapter to test leads	21
7. Insulation resistance measurement on PV systems	23
7-1 Measuring method	25
8. Insulation resistance measurement	31
8-1 Measuring method	32
9. Earth resistance measurement.....	36
9-1 Measurement principle	36
9-2 Simplified measurement	37
9-3 Precision measurement (with MODEL7228A test leads).....	40
10. Voltage measurement.....	44
10-1 Measuring method	44
11. Alarm function	46
11-1 Alarm function	46
11-2 How to set alarm	46
11-3 Display example – Alarm setting.....	48

12. Memory function	49
12-1 How to save	50
12-2 How to recall	52
12-3 How to delete	53
13. System clock settings	54
13-1 How to adjust	54
14. Data communication function	56
14-1 How to transfer data	56
15. Battery replacement.....	57
16. Shoulder strap and soft case attachment	58
16-1 How to attach shoulder strap	58
16-2 How to attach soft case.....	59

1. Safety warnings

This instrument has been designed, manufactured and tested according to IEC 61010: Safety requirements for Electronic measuring apparatus, and delivered in the best condition after passing quality control tests.

This instruction manual contains warnings and safety rules which have to be observed by the user to ensure safe operation of the instrument and to maintain it in safe condition. Therefore, read through these operating instructions before using the instrument.

WARNING

- Read through and understand the instructions contained in this manual before starting to use the instrument.
- Keep the manual at hand to enable quick reference whenever necessary.
- The instrument is to be used only in its intended applications.
- Understand and follow all the safety instructions contained in the manual.

It is essential that the above instructions are adhered to. Failure to follow the above instructions may cause injury and/or damage to the instrument.

The symbol  indicated on the instrument, means that the user must refer to the related parts in the manual for safe operation of the instrument. It is essential to read the instructions wherever the symbol appears in the manual.

 **DANGER** : is reserved for conditions and actions that are likely to cause serious or fatal injury.

 **WARNING** : is reserved for conditions and actions that can cause serious or fatal injury.

 **CAUTION** : is reserved for conditions and actions that can cause injury or instrument damage.

Measurement category

To ensure safe operation of measuring instruments, IEC 61010 establishes safety standards for various electrical environments, categorized as O to CAT IV, and called measurement categories. Higher-numbered categories correspond to electrical environments with greater momentary energy, so a measuring instrument designed for CAT III environments can endure greater momentary energy than one designed for CAT II.

O (None, Other) : Circuits which are not directly connected to the mains power supply.

CAT II : Electrical circuits of equipment connected to an AC electrical outlet by a power cord.

CAT III : Primary electrical circuits of the equipment connected directly to the distribution panel, and feeders from the distribution panel to outlets.

CAT IV : The circuit from the service drop to the service entrance, and to the power meter and primary overcurrent protection device (distribution panel).

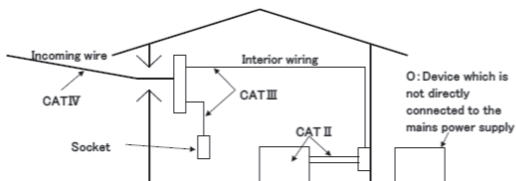

⚠ DANGER

- Never make measurements on a circuit in which earth potentials of 300 V or higher (in CAT IV)/ 600 V or higher (in CAT III) exist.
- Use the metal parts for test probes appropriate for the measurement category they are used in.
- When test probes are connected to the instrument, the lower category either of them belongs to is applied. Confirm that they are rated for the measurement voltage of the instrument to be used.

 **DANGER**

- The instrument is to be used only in its intended applications or conditions. Otherwise, safety functions equipped with the instrument don't work, and instrument damage or serious personal injury may occur.
- Verify proper operation on a known source before taking actions as a result of the indication of the instrument.
- Do not attempt to make measurement in the presence of flammable gasses. Otherwise, the use of the instrument may cause sparking, which can lead to an explosion.
- Never attempt to make connections of test leads if instrument surface or your hand is wet.
- Be careful not to short-circuit a power line with the un-insulated metal tip of the test probes to avoid injuries.
- Do not exceed the maximum allowable input of any measuring range.
- Do not press TEST button when connecting test leads to the instrument.
- Keep the battery compartment cover screwed and closed during a measurement.
- Do not touch the circuit under test while measuring insulation resistance or right after measurement to avoid electrical shock.

[Voltage test leads]



- Always use the test leads supplied with this instrument.
- Connect the test leads which are required for the measurement.
- Connect the test leads to the instrument first, and then to the measurement line.
- Keep your fingers behind the barrier during a measurement. Barrier provides protection against electrical shock and ensuring the minimum required air and creepage distances.
- Never try to disconnect the test leads from the connectors of the instrument during a measurement - while the instrument is energized.
- Do not touch two lines under test, at the same time, with the metal tips.
- Never touch the metal tips.

 **WARNING**





- The instrument is to be used only in its intended applications. Understand and follow all the safety instructions contained in the manual. Failure to follow the instructions may cause injury, instrument damage and/or damage to the equipment under test. Kyoritsu is by no means liable for any damage resulting from the instrument in contradiction to these cautionary notes.
- Never attempt to make any measurements if the test leads and/or the instrument has any structural abnormality, such as a crack or exposed metal parts.
- Do not install substitute parts or make any modifications to the instrument. Return the instrument to your local KYORITSU distributor for repair or re-calibration in case of suspected faulty operation.
- Do not try to replace batteries if the surface of the instrument is wet.
- Connect the test leads firmly to the connectors.
- When replacing batteries, power off the instrument first, and then open the battery compartment cover.

 **CAUTION**

- Select an appropriate function before starting a measurement.
- Power off the instrument after use, and disconnect the test leads.
Remove batteries if the instrument is to be stored and will not be in use for a long period.
- Do not expose the instrument to direct sunlight, high temperature, humidity or dew.
- Use a damp cloth with neutral detergent or water for cleaning the instrument. Do not use abrasives or solvents.
- Wipe the instrument with a soft cloth, if it is wet, and store it after it's dry.

Carefully read and observe the precautions with a mark of  **DANGER**,  **WARNING**,  **CAUTION** and **Note**: described in each chapter.

Symbols marked on the instrument

CAT III	Primary electrical circuits of the equipment connected directly to the distribution panel, and feeders from the distribution panel to outlets
CATIV	The circuit from the service drop to the service entrance, and to the power meter and primary over-current protection device (distribution panel)
	Instrument with double or reinforced insulation
	User must refer to the explanations in the instruction manual.
	Earth
	Never use on a circuit with voltages higher than 600V.

2. Features

KEW6024PV can measure insulation resistances of PV systems with open voltages of 1000 V or less and of low-voltage installations with voltages of 600 V or less; moreover, earth resistance and AC/ DC voltage of distribution lines and electrical appliances.

- Designed to meet the following safety standards.
 - IEC 61010-1,-2-030 CAT III 600V/ CAT IV 300V Pollution degree 2
 - IEC 61010-031
 - IEC 61557-1, -2, -5, -10
- Designed, produced and tested according to IEC60529 (IP54)
- Compact and light weight
- Backlight facilitating working in dimly lit areas
 - * The light automatically turns off if any button isn't pressed for two minutes.
- The instrument automatically turns off if any button isn't pressed for 10 minutes. This feature is disabled during a continuous measurement.
- Test probe with a remote control switch is supplied as standard accessory.
- Soft case – instrument is accessible while in use
- Strap belt allowing both hands free
- Replaceable metal tips are supplied as standard accessories
- Audible and visible live circuit warning
- Internal memory can store up to 1000 results. Data transfer and analysis to/ on a PC is possible by using the special software.
- Automatic AC/ DC detection at voltage measurement

- Insulation resistance measurement
 - When insulation resistance like a capacitive load is measured, electric charges stored in a capacitive circuit are automatically discharged after measurement. Discharge can be checked with the live warning LED, red backlight, blinking symbol on the LCD and buzzer.
 - Bar graph display
 - Buzzer beeps when the measured value drops below or exceed the pre-set threshold value.
 - For safety reasons, a long press is required to select 1000V range. It is possible to disable 1000V range.

* Special features for measurement on PV systems

- Measured voltages are displayed in stand-by mode.
 - Elapsed time, after starting a measurement, is displayed with the measured values.
 - Auto-discharge with voltage display and also with the measured value
- Earth resistance measurement
 - Measured earth voltage is displayed in stand-by mode. The LED lights up if the measured voltage is relatively high.
 - In precision measurement, warning indication will be displayed and the LED lights up if the auxiliary earth resistance it too high.
 - Easy to perform simplified measurement with two test probes on simplified measurement function.
 - Buzzer beeps when the measured value drops below or exceed the pre-set threshold value.

3. Specifications

- Measuring range and accuracy (23°C±5°C, RH 75% or less)

PV insulation resistance measurement

Rated measurement voltage (DC)	500V	1000V
Range (3-range auto)	20/ 200/ 2000MΩ	
Display range	20MΩ range : 0.00 - 19.99 MΩ 200MΩ range : 15.0 - 208.9 MΩ 2000MΩ range : 159 - 2099 MΩ	
Open voltage (DC)	Rated measurement voltage x 1 - 1.2 times * Output voltage is to be divided by the current-limiting resistor of 1 MΩ at Earth terminal and the resistor at the connected terminal.	
Short-circuit current	1.5 mA or less	
Measuring range	1.51 - 200.0 MΩ	1.51 - 1000 MΩ
Accuracy	±(1.5%rdg+5dgt)	
Measuring range	0.00 - 1.50 MΩ 200.1 - 2000 MΩ	0.00 - 1.50 MΩ 1001 - 2000 MΩ
Accuracy	±(5%rdg+6dgt)	

Voltage/ Earth voltage measurement

Measuring range	Display range (2-range auto)	Accuracy
5 to 600 V AC (45 - 65Hz)	300V range: 0.0 to 314.9 V 600V range: 240 to 629 V	±1%rdg±4dgt
±5 to ±1000 V DC	500V range: 0.0 to ±524.9 V 1000V range: ±400 to ±1049 V	

Measuring method: True RMS

* Automatically detect AC/ DC when an input voltage is 5 V or higher and show AC or DC symbol on the LCD.

* Input terminals are shown in the following table.

LINE-EARTH	when selecting a voltage function
C(H)-E	when selecting a simplified measurement function
P(S)-E	when selecting a precision measurement function

Earth resistance measurement

Precision/ simplified	Range (3-range auto)	Measuring range	Display range	Accuracy* ¹
	20Ω range		0.00 - 2000 Ω	0.00 - 20.99 Ω
200Ω range	16.0 - 209.9 Ω	±3%rdg±3dgt		
2000Ω range	160 - 2099 Ω			

Measuring method: Constant current inverter/ 825 Hz

20Ω range : approx. 3 mA

200Ω range : approx. 2 mA

2000Ω range : approx. 1 mA

* For precision measurement, auxiliary earth resistance should be 100 Ω ±5% or less.

Insulation resistance measurement

Rated measurement voltage (DC)		250V	500V	1000V
Range (3-range auto)		20/ 200/ 2000MΩ		
Effective display range		20MΩ range : 0.00 - 20.99 MΩ 200MΩ range : 16.0 - 209.9 MΩ 2000MΩ range : 160 - 2099 MΩ		
Open-circuit voltage (DC)		Rated measurement voltage x 1 - 1.2 times		
Short-circuit current		1.5 mA or less		
Rated current (Lower limit resistance)		1.0 - 1.2 mA		
		0.25 MΩ	0.5 MΩ	1 MΩ
1st effective measuring range	Measuring range [MΩ]	1.51 - 100.0	1.51 - 200.0	1.51 - 1000
	Mid. value	50 MΩ	50 MΩ	50 MΩ
	Accuracy (Intrinsic error)	±1.5%rdg±5dgt		
2nd effective measuring range	Measuring range [MΩ]	1.20 - 1.50 100.1 - 2000	1.20 - 1.50 200.1 - 2000	1.20 - 1.50 1001 - 2000
	Accuracy (Intrinsic error)	±5%rdg±6dgt		
Other measuring range		0.00 - 1.19 MΩ		
Accuracy (Intrinsic error)		±5%rdg±6dgt		

Complies with the following standards:

- IEC 61010-1, -2 -030 CAT III 600V, CAT IV 300V Pollution degree 2
- IEC 61557-1, -2, -5, -10
- IEC 60529 IP54 (MODEL7196A/ IP40, MODEL7243/ IP42)
- IEC 61326-1, -2-2 Class B
- IEC 61010-031 MODEL7196A..... CAT III 1000V, CAT IV 600V
MODEL7244A..... CAT III 1000V, CAT IV 600V^{*1}

^{*1} Using the flat test prod is CAT II 600V rated.

* When test probes, sometimes with metal tips, are connected to the instrument, the lower category either of them belongs to is applied.

- EN 50581 RoHS directive
- Location for use Altitude 2000m or less, in-door use
- Display Segment display with backlight
- Temperature & humidity range 23°C±5°C, RH85% or less
(accuracy guaranteed) (no condensation)
- Operating temperature -10°C to 50°C, RH80% or less (no condensation)
& humidity range * In a range of 40°C to 50°C, RH70% or less
- Storage temperature -20°C to 60°C, RH75% or less (no condensation)
- Withstand voltage 5160 V AC (50/60Hz) / 5 sec
Between electrical circuit and enclosure
- Insulation resistance 50MΩ or more/ 1000 V DC
Between electrical circuit and enclosure
- Auto-power-off Turns off the instrument automatically, after
a beep sound , if there is no function change,
range change or button press for about 10 min.
(*not work while performing a measurement)
- Backlight Automatically turns off if there is no activity for
about 2 min.
(*Auto-off is disabled during a measurement.)
- Dimensions 84(L) × 184(W) × 133(H) mm
- Weight Approx. 900g (including batteries)
- Power source Six size AA batteries

* Use of alkaline battery (LR6) is recommended.

- Operating uncertainty

Operating uncertainty (B) is an error obtained under the nominal operating conditions, and calculated with the intrinsic error (A), which is an error of the instrument used, and the error (En) due to variations. According to IEC61557, the maximum operating error should be within $\pm 30\%$.

- Operating uncertainty in insulation resistance measurements (IEC61557-2)

* Formula: $B = \pm (|A| + 1.15 \sqrt{E_2^2 + E_3^2})$

A	Intrinsic uncertainty
E ₁	Not applicable
E ₂	Variation due to changing the Battery voltage (till the battery indicator becomes empty" )
E ₃	Variation due to changing the temperature (-10°C to 50°C)

* E1 is not applicable since this is a digital instrument.

* The measuring range to keep operating uncertainty of $\pm 30\%$ is the same as the 1st effective measuring range.

- Operating uncertainty in earth resistance measurements (IEC61557-5)

* Formula: $B = \pm (|A| + 1.15 \sqrt{E_2^2 + E_3^2 + E_4^2 + E_5^2})$

A	Intrinsic uncertainty
E ₁	Not applicable
E ₂	Variation due to changing the Battery voltage (till the battery indicator becomes empty" )
E ₃	Variation due to changing the temperature (-10°C to 50°C)
E ₄	Variation due to series interference voltage 16·2/3 Hz, 50 Hz, 60 Hz, 10 V DC 400 Hz: 3 V
E ₅	Variation due to resistance of the auxiliary earth electrode 20Ω range: 0 – 2 kΩ 200Ω range: 0 – 20 kΩ 2000Ω range: 0 – 50 kΩ

* The measuring range to keep operating uncertainty of $\pm 30\%$ is within 5.00 Ω – 2000 Ω.

- Possible number of measurements where battery voltage is within the effective range (measurement of 5 sec., pause of 25 sec.)

Function		Test resistor	Possible number of measurements
PV Insulation resistance measurement	500V	0.5 M Ω	Approx. 2500 times
	1000V	1 M Ω	Approx. 2000 times
Insulation resistance measurement	250V	0.25 M Ω	Approx. 2500 times
	500V	0.5 M Ω	
	1000V	1 M Ω	Approx. 1500 times
Earth measurement (Simplified/ Precision)		10 Ω	Approx. 2500 times

4. Name of parts

(1) Test lead

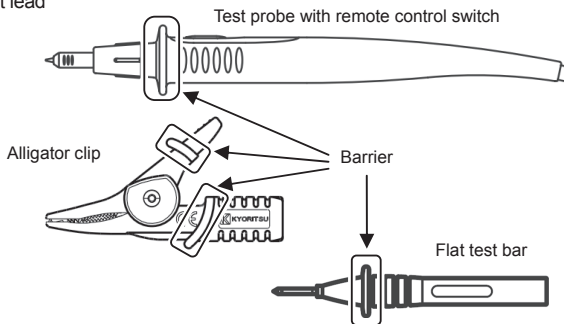

⚠ WARNING

Barrier is a part providing protection against electrical shock and ensuring the minimum required air and creepage distances. Always keep your fingers behind the barrier during a measurement.

(2) Panel side

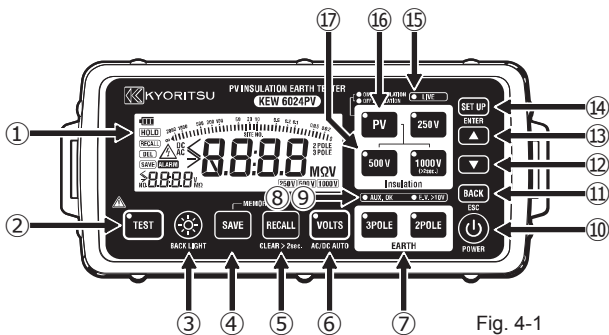

Fig. 4-1

(3) Terminal part (Connector block)

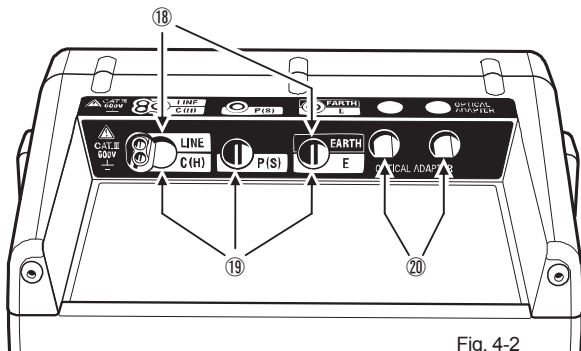
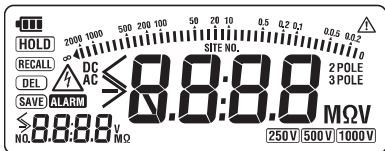

Fig. 4-2

Items – Panel side	Description
① LCD	LCD with backlight
② Test button	Starts/ stops a continuous measurement
③ Backlight button	Turns on/ off the backlight
④ Save button	Saves the measured result
⑤ Read/ delete button	Reads out or deletes the saved data
⑥ Voltage button	Measures voltages
⑦ Buttons for earth resistance measurement	Selects simplified or precision earth resistance measurement .
⑧ LED for aux. earth	Lights up in earth measurement to show the auxiliary earth electrodes are connected properly.
⑨ Earth voltage warning LED	Lights up in earth measurement if the earth voltage is relatively high.
⑩ Power button	Powers on/ off the instrument. (A long press: 1 sec. or longer)
⑪ Back button	Returns to the previous step at setting.
⑫ Down (cursor) button	Decreases setting values.
⑬ Up (cursor) button	Increases setting values.
⑭ Setup button	Configures each setting.
⑮ LED for live circuit warning	Alerts the circuit to be tested is live.
⑯ Button for insulation resistance measurement	Selects insulation resistance measurement for PV system or for the other objects.
⑰ Button for rated measurement voltages	Selects a measurement voltage for insulation resistance measurement. (A long press of 2 sec or longer is required to select 1000V.)

Items – Terminal part	Designated function	
⑱	<ul style="list-style-type: none"> ● LINE ● EARTH 	<ul style="list-style-type: none"> ● PV/ ordinary insulation measurement ● Earth (simplified) measurement ● Voltage measurement
⑲	<ul style="list-style-type: none"> ● C(H) ● P(S) ● E 	<ul style="list-style-type: none"> ● Earth (precision) measurement
⑳	OPTICAL ADAPTER	For a connection of MODEL8212USB to transfer saved data to PC

(4) LCD



● Symbols common to all functions

	Battery level indicator
	Bar graph (For PV insulation, insulation, earth measurements)
	Segments for numerical display
	Indicates “Over-range” status – the measured value is exceeding the positive display limit. e.g.: In earth measurements, “>2099Ω” may be displayed. It indicates that the measured value is exceeding 2099 Ω.
	Indicates that a measurement completes and the result is being held and displayed on the LCD.
	Flashes to provide live circuit warning (for PV insulation, insulation, earth measurement). This mark also flashes during an insulation resistance measurement.
	Indicates that alarm function is enabled.

- Symbols for PV/ ordinary insulation measurement

250V 500V 1000V	Appears to indicate the selected rated measurement voltage * 500V/1000V are selectable for PV system
MΩ	Unit
no	Appears if 1000V button is pressed where 1000 V is un-selectable.

- Symbols for earth measurement

3 POLE · 2 POLE	Appears to indicate the selected function
Ω	Unit
RC_H · RP_H	Appears to alert the aux. earth resistance is too high. (Precision measurement)

- Symbols for voltage/ earth voltage measurement

AC · DC	Indicates AC or DC
V	Unit
—	Appears to indicate negative voltage is measured.
<	Indicates "Over-range" status – the measured value is exceeding the negative display limit. e.g.: The LCD may show "< -1049V". In this case, the measured value is under "-1049 V".

- Symbols for memory function

SAVE DEL RECALL	Indicates the running operation
⚠	Appears together with the measured result containing dangerous high earth voltage.
SITE NO.	Appears when showing site no. on the LCD.
NO.	Appears when showing data no. on the LCD.

5. Accessories

- Test leads

- (1) Test probe MODEL7196A with remote control switch (red)



Changeable metal tips are available for MODEL7196A.

- (2) CAT II standard prod MODEL8072
... 1 pce

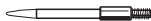

Fig. 5-2

Thin tip metal parts

- (3) Extension prod MODEL8017
... 1 pce



Fig. 5-3

Long type and helpful to access the distant measurement spot

* These metal tips are for MODEL7196A.

- (4) A set of test leads with alligator clip MODEL7244A

- (5) Black cord with banana plugs at both ends



- (6) Alligator clip



- (7) Flat test bar



- (8) L-shaped probe MODEL7243
(Optional accessory)

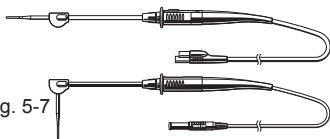

- (9) Hook type prod MODEL8016
(Optional accessory)

* Attached and used with MODEL7196A.



To hook the probe on a conductor

(10) Precision measurement cord set MODEL7245A (Optional accessory)

(11) Test leads for precision
measurement MODEL7228A
Red 20m Yellow 10m Green 5m

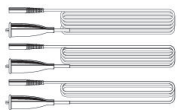
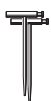

Fig. 5-9

(12) Auxiliary earth spike
MODEL8032
215mm(L)×110mm(W)



*A pair of two spikes

Fig. 5-10

(14) Cord reel (3 pcs)
MODEL8200-03

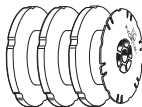

Fig. 5-11

(13) Carrying bag
MODEL9142

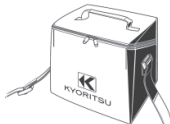

Fig. 5-12

● Other accessories

(1) Carrying case MODEL9156

(2) Shoulder strap(with cord belt) MODEL9155

(3) Six AA alkaline batteries (LR6)

(4) Instruction manual

(5) USB adapter + KEW Report (software) MODEL8212 USB

(6) USB adapter

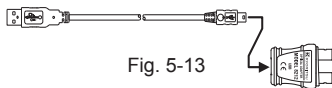

Fig. 5-13

(7) CD(KEW Report)





Fig. 5-14

(8) Instruction manual for MODEL8212 USB

6. Preparations for measurement

6-1 Battery voltage check

- (1) Please refer to “15. Battery replacement” in this manual and insert batteries in KEW6024PV.
- (2) Hold down the Power button at least 1 sec and power on the instrument.
* A long press of 1 sec or longer is required to power on/ off the instrument in order to prevent a malfunction.
- (3) Battery level indicator appears at the upper left on the LCD. Battery voltage is extremely low if “” indicator is displayed. Replace batteries with reference to “15. Battery replacement” to carry out further measurements. If empty “” indicator is displayed, battery voltage is below the lower limit of the operating voltage. In such a condition, accuracy of the measured result isn't guaranteed.

When powering on the instrument with completely exhausted batteries, empty battery indicator “” blinks in the LCD and also buzzer sounds approx. 2 sec.

Use of AA alkaline battery (LR6) is recommended. Use of other batteries may cause improper indication of battery level.

6-2 Attaching metal tip/ adapter to test leads

The following replaceable metal tips and adapters are available depending on applications.

- (1) For MODEL7196A:
 1. MODEL8072 : Standard metal tip installed at a shipment
 2. MODEL8017 : Long type and helpful to access the distant
 3. MODEL8016 : Hook type prod (optional accessory)

[How to replace the parts]

Detach the tip of Line probe by turning it counter-clockwise. Insert the metal tip you want to use into the hexagon hole, and turn the tip part of the probe clockwise to tighten firmly.

Note: Molded standard metal parts should be used in CAT III or IV environment. Rated categories are written with the model name of each parts. Always use the metal tips rated for the measurement category.

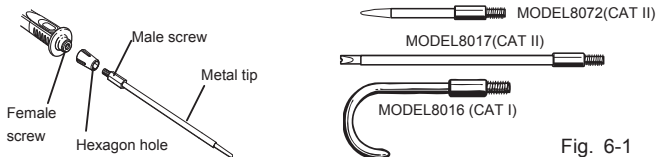

Fig. 6-1

(2) For MODEL7244A

Either of the following adapters can be attached to MODEL7244A.

1. Alligator clip
2. Flat test bar

[How to attach]

Firmly insert and connect the adapter to the end of the cord (with banana plugs at both ends).

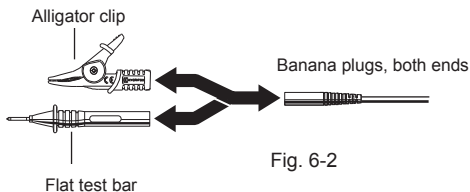

Fig. 6-2

⚠ DANGER

- To avoid getting electrical shocks, ensure that test leads are disconnected from the instrument when replacing the metal tip or adapter for test leads.

7. Insulation resistance measurement on PV systems

Measure the insulation resistance of PV system to verify insulation of PV array/ string. Before starting a measurement, confirm the voltage value which can be applied to the object under test.

Note:

- Insulation resistance of PV array may be low if it is measured in rain or high humidity. In addition, it takes longer time to get the result due to large static capacitances (to earth) in such weather.
- Some objects have unstable insulation resistance and may cause unstable readings.
- Select the insulation resistance function for PV system to measure the insulation resistance of PV array.
- The instrument may give bleep during an insulation resistance measurement, however, this is not a malfunction.
- The earth measuring terminal outputs positive voltage and the line measuring terminal negative voltage.
- Connect the earth cord to the earth (ground) terminal at measurement. It is recommended to connect the positive side to the earth side when measuring insulation resistance against ground or when a part of the object under test is earthed. Such connection is known to be more suitable for insulation testing since insulation resistance values measured with the positive side connected to earth are typically less than those taken through the reversed connection.

 **DANGER**

- Be extremely careful not to touch the tip of test probe or circuit under test to avoid electrical shock during insulation resistance measurement as high voltage is present on the tip of the test probe continuously.
- Wipe the test probe with a soft cloth, if it is wet, and use it after it's dry.
- Never make measurements with the battery compartment cover removed.

 **WARNING**

- Always disconnect power to the conductor under test before starting insulation measurement. Do not attempt to make measurements on a live conductor. Otherwise, it may damage the instrument.
- Before starting insulation resistance measurement on PV array, turn off the main switch and disconnect the array from the solar inverter.
- Do not make measurement if any malfunction of PV array is suspected.
- Select and use ordinary insulation resistance measurement function when measuring a conductor with P-N short-circuited.
- PV arrays generate dangerous voltages and current during the day. Measures for work in high voltage environment should be taken and appropriate protective gears must be used.

7-1 Measuring method

DANGER

- Do not measure PV arrays with open-circuit voltage of 1000 V or more.

CAUTION

- Test and verify the insulation of P terminal prior to measuring insulation resistance between N and earth terminals of PV array. If the measured resistance value is low, do not perform further measurement so as not to damage solar cells and modules.

- (1) Press the PV button to select insulation resistance function for PV system.
The LCD shows “SOLA” about one second and the PV LED lights up.
- (2) Connect the test leads as Fig. 7-1 shows.
MODEL7196A to LINE terminal, and MODEL7244A to EARTH terminal

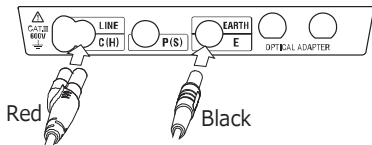

Fig. 7-1

- (3) Follow the procedures described on the next page and open-circuit the circuit to be measured.

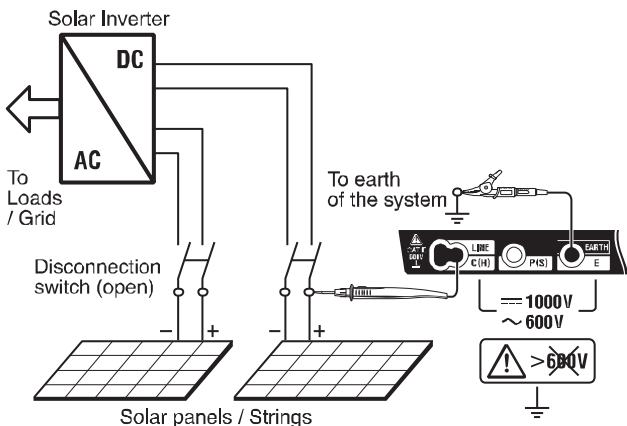

Fig. 7-2

⚠ CAUTION

This is just an example and the PV system connection may be different from actual one. Always check the actual connection before starting measurement.

1. Turn off the main switch of the solar PV installation following the procedures according to the PV installation or solar Inverter instruction manual.
 2. Turn off all disconnection switches and disconnect each string.
 3. In case of presence of SPDs (Surge Protection Devices) they must be disconnected during all testing.
 4. Before measurement, it is recommended to remove any electrical / electronic device with lower withstand voltage rating than the test voltage that is connected to the circuit under test.
 5. If N-terminals of strings in circuit under test are earthed, disconnect them before starting measurement.
- (4) Confirm the voltage rating of the circuit under test, and press the button for rated measurement voltage to select the voltage applied.
- * A long press (2 sec or longer) is required to select 1000V.
 - * It is possible to disable 1000V range.
[How to disable/enable 1000V range]
 1. Keep the 1000V button held down and power on the instrument.
 2. Wait for about 5 seconds with the 1000V button held down to disable/enable 1000V range.

[How to confirm 1000V is surely disabled]
The LCD shows “no” when pressing 1000V button.

- (5) Connect the earth test lead (MODEL7244A) to the earth terminal of the circuit under test. Then, place the tip of remote probe (line) to P terminal of the string.

Confirm that the voltage in the circuit under test is not high (usually less than 50V). If high voltage is detected, impaired insulation is suspected.

The instrument may give live circuit warning while the subject string is generating voltage, but can perform measurement where the voltage is positive dc and less than the rated measurement voltage.

Note: Select the insulation resistance function for PV systems.

⚠ DANGER

- Never make measurements on a circuit in which earth potentials of 600 V or higher exist.

⚠ CAUTION

- Always turn off the breaker of the measurement line. The instrument cannot make measurement on circuits energized with AC voltage or to which negative DC voltage is being applied. Measurement in such live circuit conditions may damage the instrument.

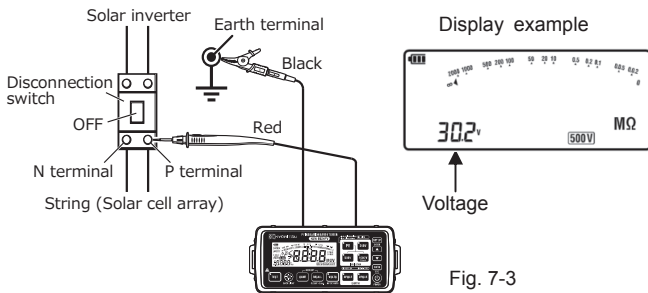

Fig. 7-3

(6) Press the TEST button or remote control switch to start a continuous measurement.

Note: Sometimes the insulation resistance value takes long time until becomes stable because the string capacitance is big.

It is possible to relatively compare the insulation resistance value of each string taking the reading after 1 minute of testing, so without waiting for long time until the value is stable.

The LCD shows “>2099MΩ” when the measured result exceeds the display range (over-range).

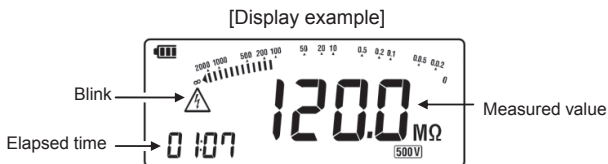
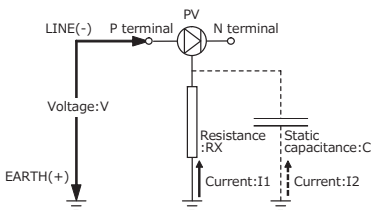

Fig. 7-4

(7) Press TEST or remote control switch again to stop a continuous measurement.

PV Insulation resistance – Measurement principle



- Influences of voltage and current generated by PV system are subtracted.
- Flow of current I_2 stops when static capacitance C is fully charged.

$$\text{Resistance} = \text{Voltage} / \text{Current}$$

$$RX = V / (I_1 + I_2)$$

Fig. 7-5

(8) [Auto discharge function]

This function allows electric charges stored in the capacitance of the circuit under test to be automatically discharged after measurement.

Set the TEST button or remote control switch to off with the test leads connected. Discharge can be monitored by the readings displayed at the lower left of the LCD and also by live circuit warning LED, red backlight and blinking  mark.

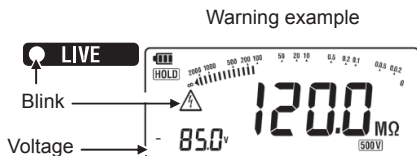

Fig. 7-6

(9) Press the POWER button to power off the instrument when measurement completes, and then disconnect the test leads from the instrument.

 **DANGER**

- Never touch the circuit under test immediately after measurement. Capacitances stored in the circuit may cause electric shock. Leave the test leads connected to the circuit and do not touch the circuit until the voltage value displayed at the lower left corner of the LCD becomes positive dc value, live circuit warning LED turns off and audible warning stops.

8. Insulation resistance measurement

This instrument is used to measure insulation resistance in electric appliance or circuit to inspect the insulation performance. Check the voltage rating of the object to be tested before making measurement and select the voltage applied to.

Note:

- Depending on the object being measured, displayed insulation resistance value may not stabilize.
- The instrument may give bleep during an insulation resistance measurement, however, this is not a malfunction.
- Measurement time may be longer when measuring capacitive load.
- In insulation resistance measurement, the earth terminal outputs positive voltage and the line terminal negative voltage.
- Connect the earth cord to the earth (ground) terminal at measurement.

It is recommended to connect the positive side to the earth side when measuring insulation resistance against ground or when a part of the object under test is earthed. Such connection is known to be more suitable for insulation testing since insulation resistance values measured with the positive side connected to earth are typically less than those taken through the reversed connection.

 **CAUTION**

- Be extremely careful not to touch the tip of test probe or circuit under test to avoid electrical shock during insulation resistance measurement as high voltage is present on the tip of the test probe continuously.
- Wipe the test probe with a soft cloth, if it is wet, and use it after it's dry.
- Never make measurements with the battery compartment cover removed.

8-1 Measuring method

(1) Press the PV button to select insulation measurement function. The LCD shows "InSU" for about one second, and the PV LED turns off.

(2) Connect the test leads as Fig. 8-1 shows.

MODEL7196A to LINE terminal, and MODEL7244A to EARTH terminal

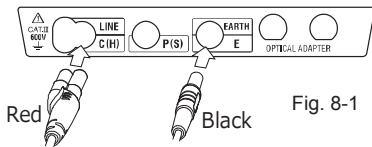

(3) Check the voltage rating of the object to be tested before making measurement and select the voltage applied with the rated measurement voltage button.

- Hold down 1000V button two seconds or longer.
- It is possible to disable 1000V range.

[How to disable/enable 1000V range]

1. Keep the 1000V button held down and power on the instrument.
2. Wait for about 5 seconds with the 1000V button held down to disable/enable 1000V range.

[How to confirm 1000V is surely disabled]

The LCD shows "no" when pressing 1000V button.

(4) Connect the earth test lead (MODEL7244A) to the earth terminal of the circuit under test. Then, place the tip of remote probe (line) to the circuit under test and press TEST or remote control switch to start a continuous measurement. Press TEST or remote control switch again to stop measurement.

CAUTION

- Always disconnect power to the conductor under test before starting insulation measurement. Do not attempt to make measurements on a live conductor. Otherwise, it may damage the instrument.

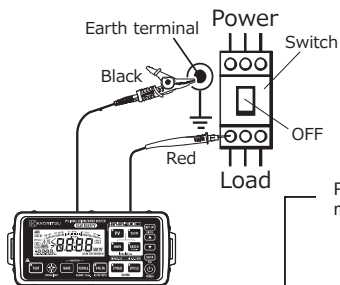

Fig. 8-3



Fig. 8-2

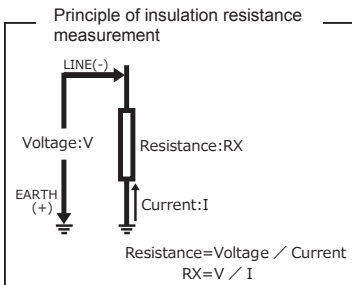



Fig. 8-4

The LCD shows ">2099MΩ" when the measured result exceeds the display range (over-range).

(5) [Auto discharge function]

This function allows electric charges stored in the capacitance of the circuit under test to be automatically discharged after measurement. Set the TEST button or remote control switch to off with the test leads connected. Discharge can be monitored by the readings displayed at the lower left of the LCD and also by live circuit warning LED, red backlight and blinking  mark.

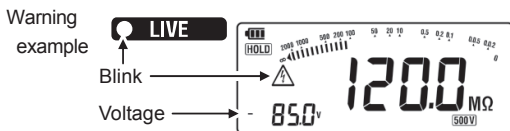

Fig. 8-5

Pressing the BACK button during discharging allows you to monitor the discharge voltage. In this case, the measured insulation value will be cleared and go off from the screen.

- (6) Press the POWER button and power off the instrument when measurement completes, and then disconnect the test leads from the instrument.

 **DANGER**

- Never touch the circuit under test immediately after measurement. Capacitance stored in the circuit may cause electric shock. Leave the test leads connected to the circuit and do not touch the circuit until live circuit warning LED and warning mark stop blinking.

(7) Output voltage characteristics

This instrument conforms to IEC61557-2. This standard specifies that the rated current shall be at least 1 mA and thus defines the lower limit of the insulation resistance to maintain the rated voltage at the measurement terminal. (See the graph below.)

This value is calculated by dividing the rated voltage by rated current. i.e., in case that the rated voltage is 500 V, the lower limit of the insulation resistance is found as follows.

Divide 500 V by 1mA equals 0.5 M Ω .

That is, insulation resistance of 0.5 M Ω or more is required to provide the rated voltage to the instrument.

Rated voltage	250 V	500 V	1000 V
Lower limit of insulation resistance to supply rated measurement current (1 mA)	0.25 M Ω	0.5 M Ω	1 M Ω

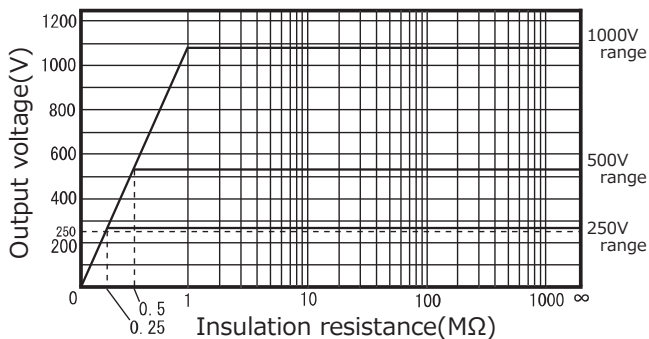

Fig. 8-6

9. Earth resistance measurement

With the earth resistance measurement function of this instrument, earth resistance of power distribution lines, in-house wiring system and electrical appliances can be measured.

DANGER

- The instrument will produce a maximum voltage of about 50 V between C (H) and E terminals at earth resistance measurement. Take enough caution to avoid electric shock hazard.
- When measuring earth voltage, do not apply voltage greater than 600 V between measuring terminals.
- When measuring earth resistance, do not apply voltage between measuring terminals.

9-1 Measurement principle

This instrument makes earth resistance measurement with fall-of-potential method, which is a method to obtain earth resistance value R_x by applying AC constant current I between the measurement object **E** (earth electrode) and **C** (current electrode), and finding out the potential difference V between **E** and **P** (potential electrode).

$$R_x = V / I$$

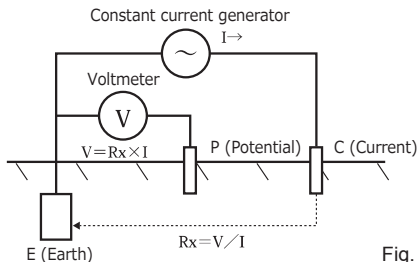

Fig. 9-1

9-2 Simplified measurement

Use this method when the auxiliary earth spike cannot be stuck. In this method, an existing earth electrode with a low earth resistance, such as a metal water pipe, a common earth of a commercial power supply and an earth terminal of a building, can be used with two-pole method (E and P).

(1) Connect the test leads as Fig. 9-2 shows.

MODEL7196A to LINE (C) terminal, and MODEL7244A to EARTH (E) terminal

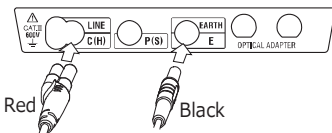
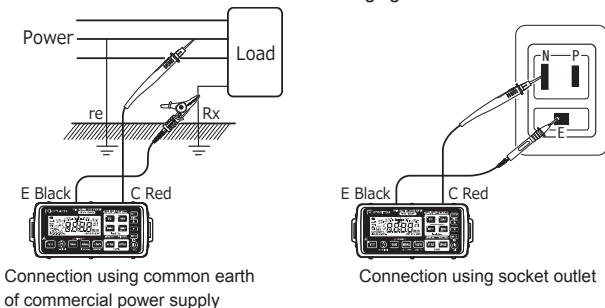

Fig. 9-2

(2) Wiring

Make connection as shown in the following figure.



Connection using common earth of commercial power supply

Fig. 9-3

Connection using socket outlet

Fig. 9-4

⚠ DANGER

- Use a voltage detector to check a common earth of commercial power supply.
- Do not use this instrument to check a common earth of commercial power supply.

A danger will be caused because the voltage may not be displayed even in case of a live conductor, when the connection of the earth electrode to be measured has come off, or when the connection of the test leads of the instrument is not correct etc.

(3) Earth voltage check

- Press the 2POLE button and select simplified measurement function. Then, 2POLE mark is displayed on the LCD.
- In the connection state of Fig. 9-3 or 9-4, check the earth voltage displayed on the LCD. The earth voltage displayed in this state is the voltage between C(H) and E terminals.

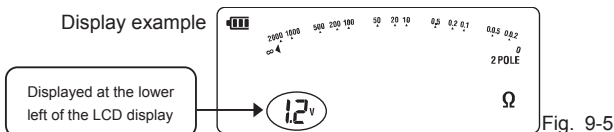

Make sure that the voltage is less than 10 V. When the display reads 10 V or more, a warning LED as shown below lights up. (The warning LED lights up at 5 V or more for an earth voltage of 400 Hz.)

● AUX. OK ● E.V. >10V

Red LED lights up. Fig. 9-6

Excessive errors in earth resistance measurement may be caused in the condition that warning LED for high earth voltage is lighting up. To avoid this, make measurement after reducing the voltage by turning off the power supply of the equipment under test etc.

(4) Measurement

- Press TEST or the remote control switch to start a continuous measurement. Press TEST or remote control switch again to stop measurement.

Display example

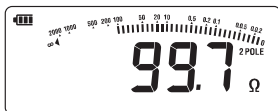

Fig. 9-7

The LCD shows “>2099Ω” when the measured result exceeds the display range (over-range).

(5) Simplified measurement value

Two-pole method is used for simplified measurement. In this method, earth resistance value **re** of earth electrode connected to terminal C(H) - see Fig. 9-3 - is added to true earth resistance value **R_x** and shown as an indicated value **Re**.

$$\mathbf{Re = Rx + re}$$

If the **re** is known beforehand, true earth resistance value **R_x** is calculated as follows.

$$\mathbf{Rx (true\ resistance) = Re - re}$$

9-3 Precision measurement (with MODEL7228A test leads)

(1) Connection

Switch the auxiliary earth spikes P(S) and C(H) into the ground deeply. They should be aligned at an interval of 5 - 10 m from the earthed equipment under test. Connect the green wire to the earthed equipment under test, the yellow wire to the auxiliary earth spike P(S) and the red wire to auxiliary earth spike C(H) from terminals E, P(S) and C(H) of the instrument in order.

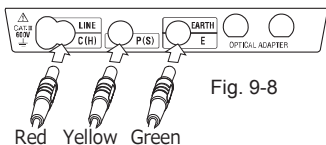

Use MODEL7228A test leads for measurement.

Connect the red wire (20m) to C(H) terminal, yellow wire (10m) to P(S) terminal and green wire to E terminal.



MODEL7228A(with cord reel)

Fig. 9-9

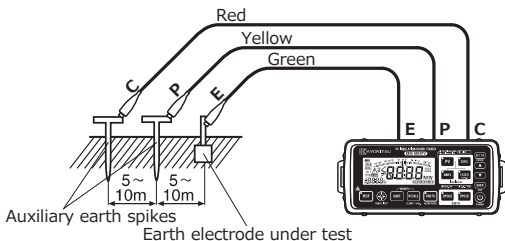

Note:

Make sure to stick the auxiliary earth spikes in the moist part of the soil. Give enough water where the spikes have to be stuck into the dry, stony or sandy part of the earth so that it may become moist.

In case of concrete, lay the auxiliary earth spike down and water it, or put a wet cloth etc. on the spike when making measurement.

(2) Earth voltage check

- Press the 3POLE button and select precision measurement function. Then, 3POLE mark is displayed on the LCD.
- In the connection state of Fig. 9-10, check the earth voltage displayed on the LCD. The earth voltage displayed in this state is the voltage between P(S) and E terminals.

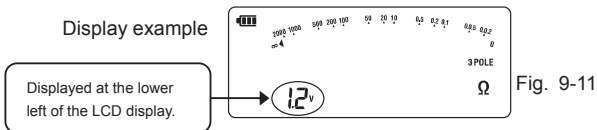

Make sure that the voltage is less than 10 V. When the display reads 10 V or more, the warning LED as shown below lights up. (The warning LED lights up at 5 V or more for an earth voltage of 400 Hz.)



Excessive errors in earth resistance measurement may be caused in the condition that warning LED for high earth voltage is lighting up. To avoid this, make measurement after reducing the voltage by turning off the power supply of the equipment under test etc.

(3) Measurement

Press TEST or the remote control switch to start a continuous measurement. Press TEST or remote control switch again to stop measurement.

Display example



Fig. 9-13

The LCD shows ">2099Ω" when the measured result exceeds the display range (over-range).

(4) Auxiliary earth resistance

If the auxiliary earth resistance is within the allowable range and doesn't affect measurement, the LED (AUX. OK) lights up.



Green LED lights up. Fig. 9-14

If the auxiliary resistance of auxiliary spike P or C is too high to make measurement, the display reads "RP_H" or "RC_H". Recheck the connection of test leads and the earth resistance of auxiliary earth spike.

When RP is too high:



Fig. 9-15

When RC is too high:

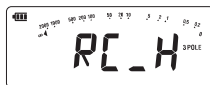

Fig. 9-16

 **DANGER**

- If measurement is made with the test leads twisted or in touch with each other, the reading of the instrument may be affected by induction. When connecting the test leads, make sure that they are separated.
- If earth resistance of auxiliary earth spikes is too large, it may result in inaccurate measurement. Make sure to stick the auxiliary earth spike P(S) and C(H) into the moist part of the earth carefully, and ensure sufficient connections between the respective connections.
- If auxiliary earth resistance is higher than 100 times of the upper limit value of the selected measurement range, the measured result may be displayed on the next higher range.

e.g.:

When the measured result is 10 Ω , the LCD normally shows "10.00 Ω ", however, it may show "10 Ω ".

10. Voltage measurement

⚠ DANGER

- Do not apply a voltage exceeding the maximum allowable input (600 V AC/ 1000 V DC) to the instrument and between terminals.

10-1 Measuring method

- (1) Press the VOLTS button to select voltage measurement function.
- (2) Connect the test leads as Fig. 10-1 shows.

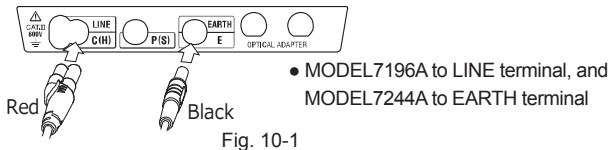

- (3) Connect the black test lead to the earth side of the circuit under test and the red remote probe to the line side.

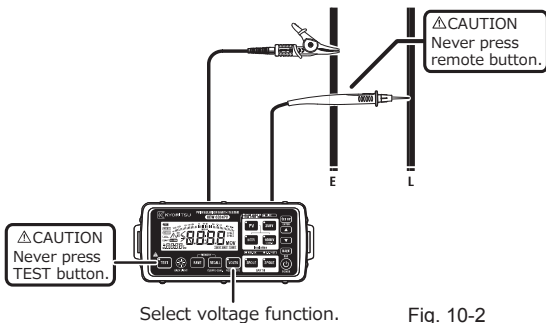

(4) Check the reading on the LCD without pressing TEST or remote control button. The instrument detects AC/ DC automatically, and shows “DC” for dc input and “AC” for ac input on the LCD.

- As for dc inputs, the negative polarity sign “-” is displayed to the left of the reading where the line probe side is charged with negative polarity.
- When the measured voltage is less than 5 V, any of AC, DC or polarity symbols don’t appear.

When the measured result exceeds the display range (over-range), the LCD reads as follows.

AC voltage : > 629 V

Positive DC voltage : > 1049 V

Negative DC voltage : <- 1049 V



11. Alarm function

11-1 Alarm function

Compare the measured result and the pre-set reference value on PV insulation measurement, insulation measurement and earth measurement functions and notify the result to the user with buzzer.

- Select any of the following reference values or enter a desired value.
Different values can be set for each range.

Function	Alarm function – Reference value
Insulation meas. (MΩ) & PV insulation meas.	0.1, 0.2, 0.25, 0.4, 0.5, 1, 2, 3, 5, 10, 20, 30, 50, 100
Earth meas. (Ω)	1, 2, 3, 4, 5, 10, 20, 30, 50, 100, 200, 300, 500, 1000

- When “>” is selected at alarm setting, buzzer sounds and blinking “>” mark and the pre-set reference value are displayed when the measured value exceeds the reference value.
- When “<” is selected at setting, buzzer sounds and blinking “<” mark and the pre-set reference value are displayed when the measured value is less than the reference value.
- This function is disabled if “OFF” is selected. (Default setting: OFF)

11-2 How to set alarm

The following figures (Fig. 11-1 to 11-7) show how to set alarm. The setting procedures described below are common to all functions. Pressing the BACK button in setting process returns to the previous step.

Stand-by state

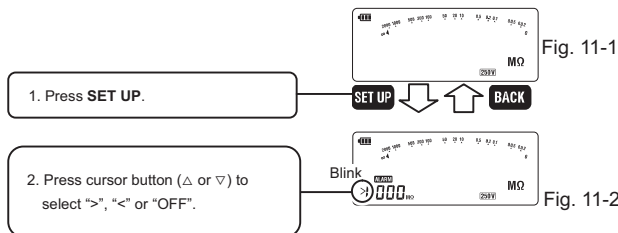

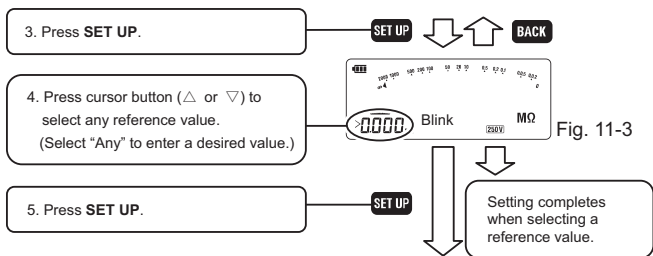

Fig. 11-3

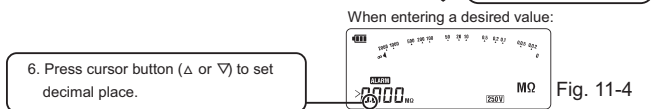

Fig. 11-4

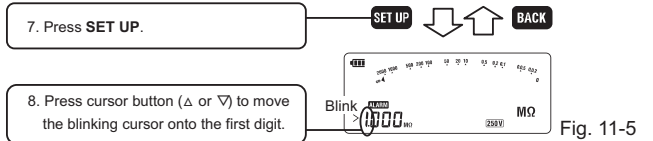

Fig. 11-5

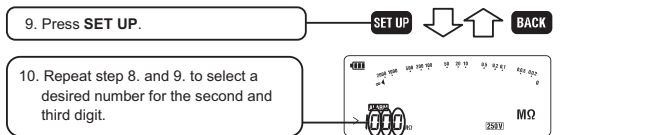

Fig. 11-6

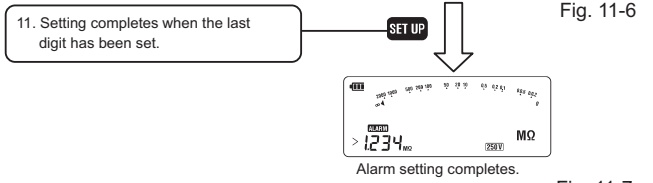

Fig. 11-7

11-3 Display example – Alarm setting

Insulation measurement
(stand-by state)

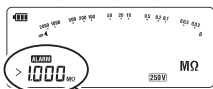

Fig. 11-8

Earth measurement
(stand-by state)



Fig. 11-9

Alarm mark and the pre-set reference value are displayed while alarm function is enabled. When starting a PV insulation or earth resistance measurement, the alarm mark will only be displayed.

Insulation measurement
(during measurement)



Fig. 11-10

Earth measurement
(during measurement)



Fig. 11-11

- When ">" has been selected, buzzer sounds and blinking ">" mark and the pre-set reference value are displayed when the measured value exceeds the reference value.
- When "<" is selected at setting, buzzer sounds and blinking "<" mark and the pre-set reference value are displayed when the measured value is less than the reference value.
- Indications remain the same at PV insulation measurement. Buzzer sounds when the measured value is greater or lower than the pre-set reference value.

12. Memory function

Results measured in PV insulation resistance, voltage, insulation resistance and earth resistance measurements can be saved in the memory of the instrument. (max. 1000) In addition, two different location numbers can be allocated to each data.

Parameters saved with the results	Detail	Range
Saved time and date	Time and date when the data saved is recorded automatically. Note: <ul style="list-style-type: none">● Note the measured time and date.● Data transfer to PC is required to view the saved time and date.	-
Data no.	Select and allocate a data no. to save a result. Number will automatically be given in sequence.	0 - 999
Site no. 1	Specify and allocate a desired site no. to a measured data. (E.g.: Give a specific no. to the building where the measurement is done.)	0 - 99
Site no. 2	Specify and allocate a desired site no. to a measured data. (E.g.: Give a specific no. to the distribution panel where the measurement is done.)	0 - 99

12-1 How to save

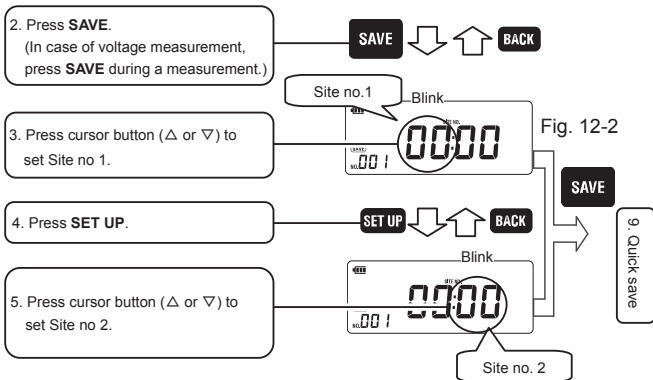
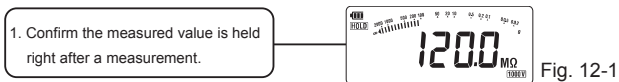
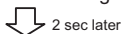
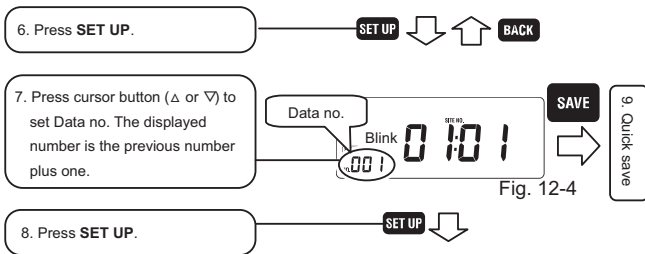

Fig. 12-3

- Quick save

Pressing **SAVE** at any of steps 3 through 7 can save the data without entering Site no. 1, 2 and Data no. In this case, the instrument automatically assigns each number; Site no. 1 and 2 will be the same as the last time and Data no. will be the previous number plus one.



Returns to the state at the beginning.
(Measured result is held and displayed)



12-2 How to recall

Follow the procedures below to recall the saved data.

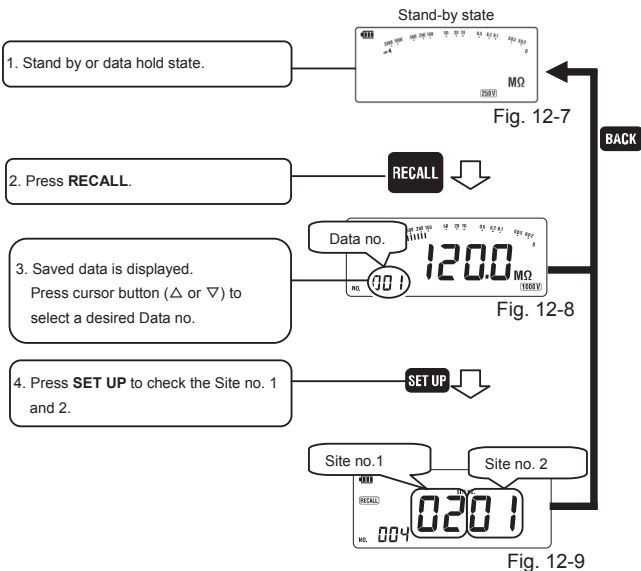

Note:

- When recalling PV insulation resistance data, the LED on PV button lights up.
- When recalling the data saved with earth voltage alert, “ Δ ” mark is also displayed on the LCD.

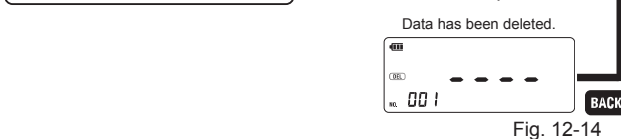
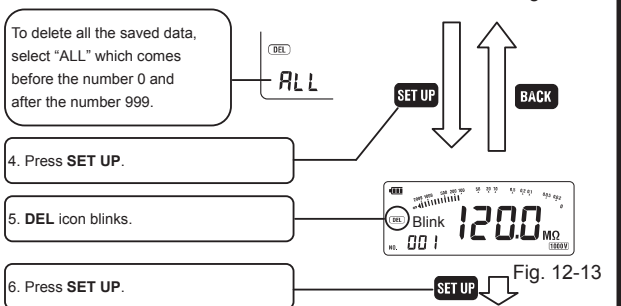
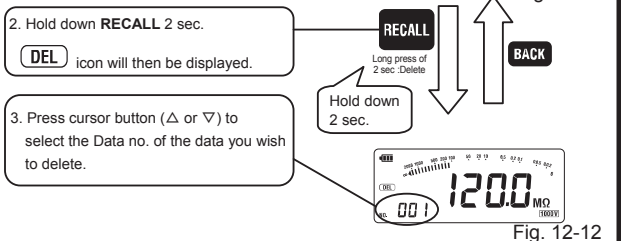
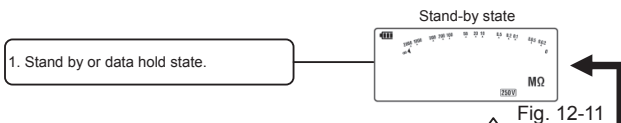

Fig. 12-10

The warning mark appears when recalling data for which earth voltage alert was given.

12-3 How to delete

Follow the procedures below to delete the saved data.



13. System clock settings

To adjust the date and time of internal system clock, follow the steps below. When saving measured results in the internal memory, date and time information will be saved together.

* Not the date and time when the measurement was performed.

13-1 How to adjust

- The following figures show how to set the system clock.
- The clock setting is allowed only on stand-by screen for voltage measurement.
- Pressing the BACK button in setting process returns to the previous step.

Stand-by state: voltage measurement



Fig. 13-1

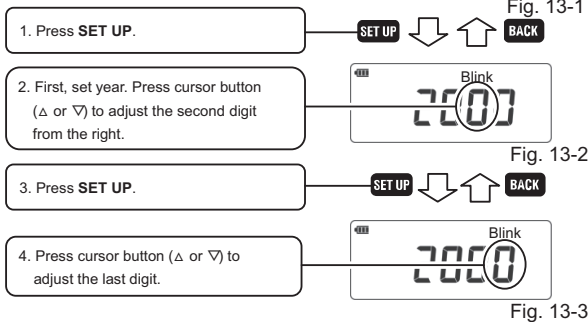
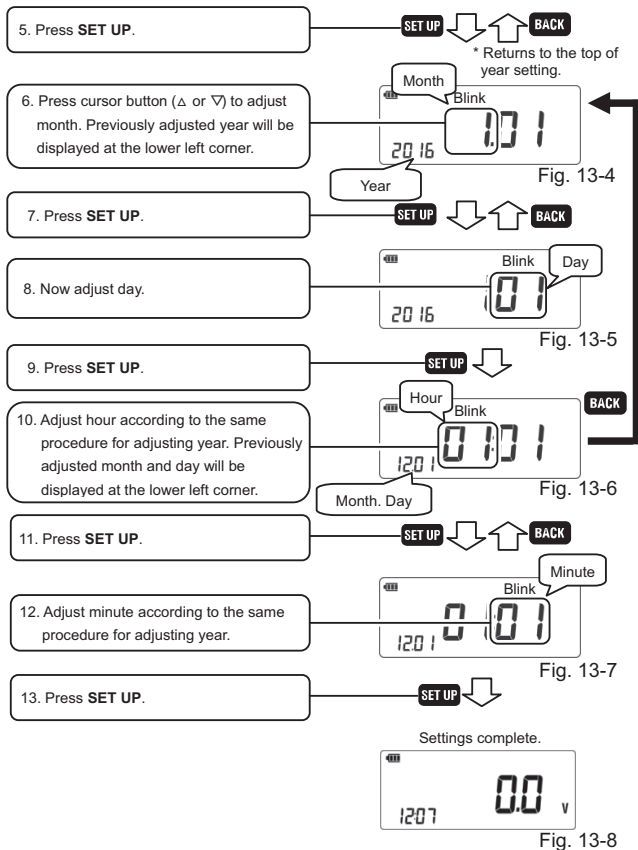

Fig. 13-2

Fig. 13-3



14. Data communication function

Data transfer to PC is possible by using our optical adapter MODEL8212 USB.

14-1 How to transfer data

- (1) Install “KEW Report” first before trying to transfer data to PC.
- (2) Connect the plug of MODEL8212 USB to the USB port on the PC.
- (3) Disconnect the test leads from the instrument, and then connect MODEL8212 USB as follows.

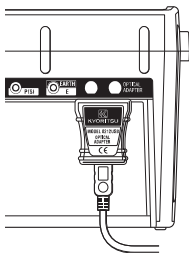



Fig. 14-1

- (4) Power on the instrument. * Selecting any function is just all right.
- (5) Run “KEW Report” and click **Download** command. Then the data will be transferred from the instrument to PC.

For further details, please refer to the instruction manual for 8212USB and HELP for KEW Report.

15. Battery replacement

When the battery indicator shows empty “”, replace the batteries with new ones.

DANGER

- Do not open the battery compartment cover if the instrument is wet.
- Never attempt to replace batteries during a measurement. In order to avoid getting electrical shock, ensure that the instrument is powered off and test leads are disconnected from the instrument before replacing batteries.
- The battery compartment cover must be closed and screwed before starting a measurement. Otherwise, electrical shock hazard may be caused.

CAUTION

- Do not mix new and old batteries or mix different types of batteries.
- Install batteries in correct polarity as marked inside.

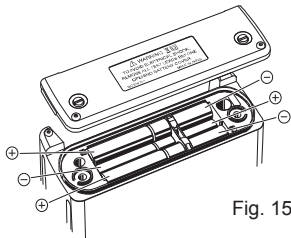

Fig. 15-1

- (1) Power off the instrument, and then disconnect the test leads.
- (2) Loosen two screws which are fixing the battery compartment cover, and remove the cover.
- (3) Replace all six batteries with new ones at the same time. Be sure that the battery polarity is correct.

Use of six size AA alkaline batteries (LR6) is recommended.

- (4) Install the battery compartment cover, and tighten two screws for the cover.

16. Shoulder strap and soft case attachment

16-1 How to attach shoulder strap

- (1) Run the side belt through the slider
as Fig. 16-1 shows. (for two side belts)

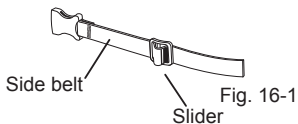

- (2) Attach the side belt as
Fig. 16-2 shows.
(to both sides)

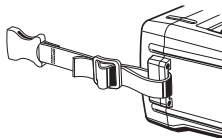

- (3) Attach the shoulder strap to the
side belt as Fig. 16-3 shows.

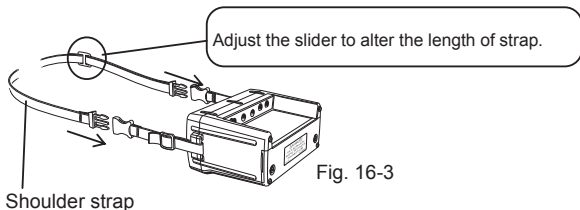

16-2 How to attach soft case

Put the instrument into the soft case as Fig. 16-4 shows. Follow the arrows with number 1 and 2 in sequence.

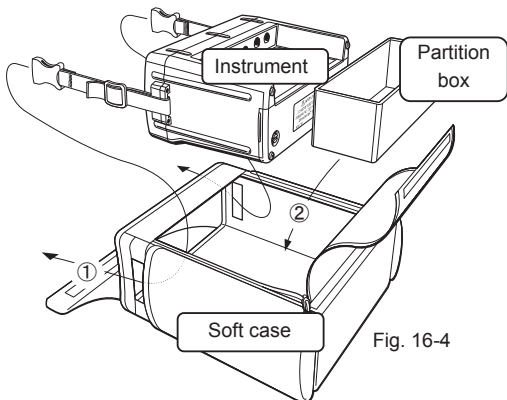

Fig. 16-4

- (1) Run the side belts through the slits on the soft case, and put the instrument into the soft case.
- (2) Place the partition box to the bottom of the soft case. Test leads can be stored in this box.

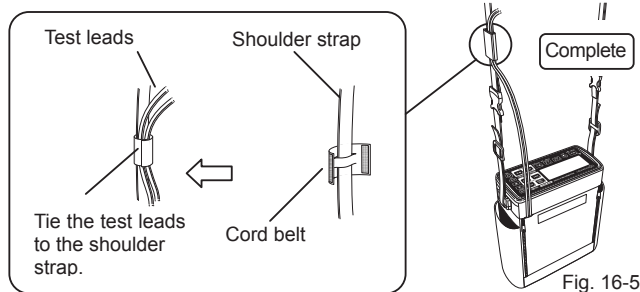

Fig. 16-5

Memo

DISTRIBUTOR

Kyoritsu reserves the rights to change specifications or designs described in this manual without notice and without obligations.



**KYORITSU ELECTRICAL
INSTRUMENTS
WORKS, LTD.**

2-5-20, Nakane, Meguro-ku,

Tokyo, 152-0031 Japan

Phone: +81-3-3723-0131

Fax: +81-3-3723-0152

Factory: Ehime, Japan

www.kew-ltd.co.jp